

Z28

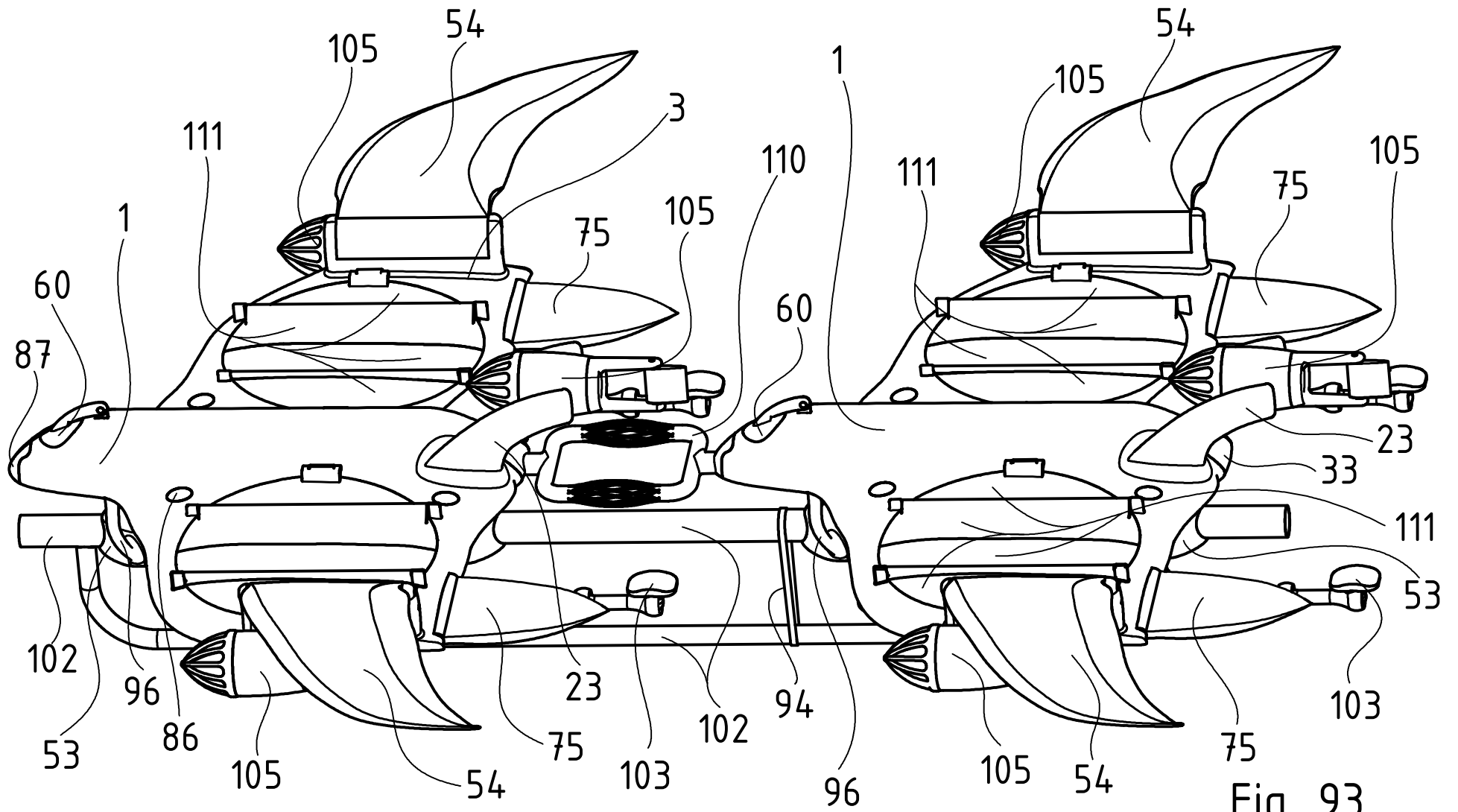

Fig. 93