

Z25

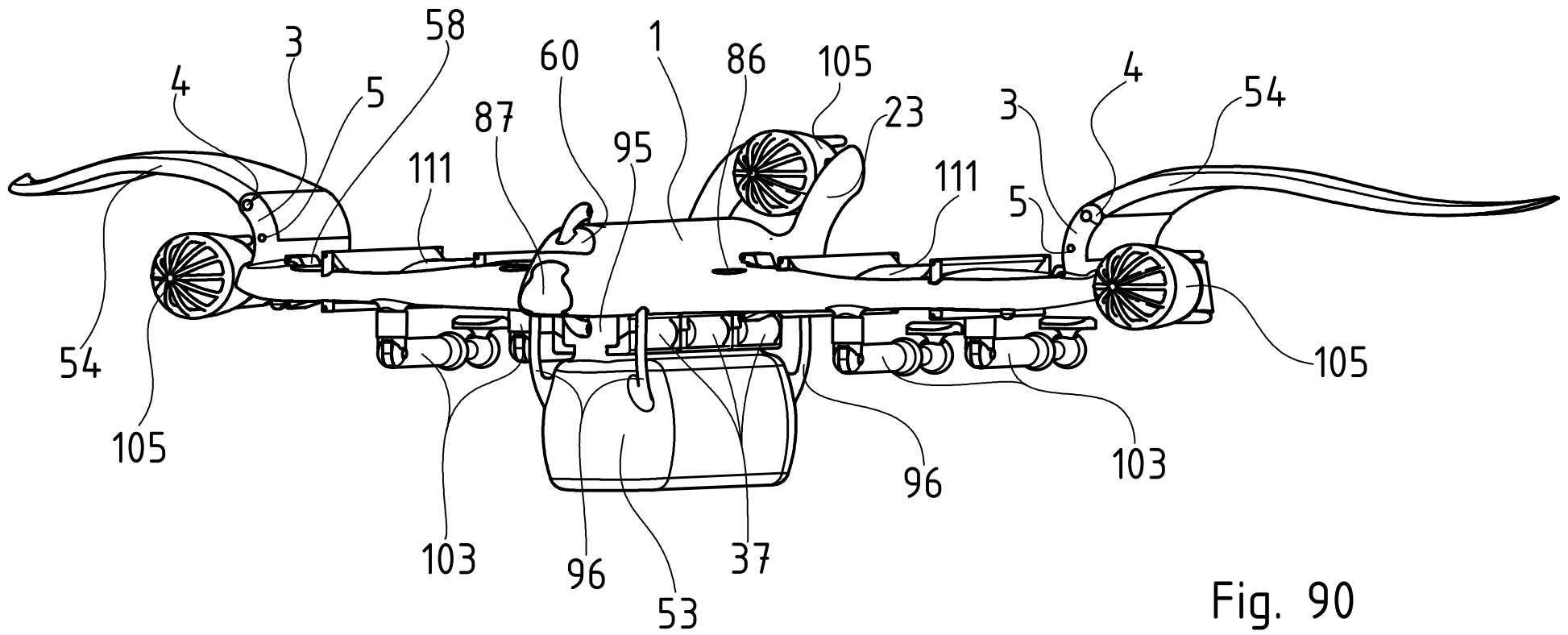

Fig. 90