

Z24

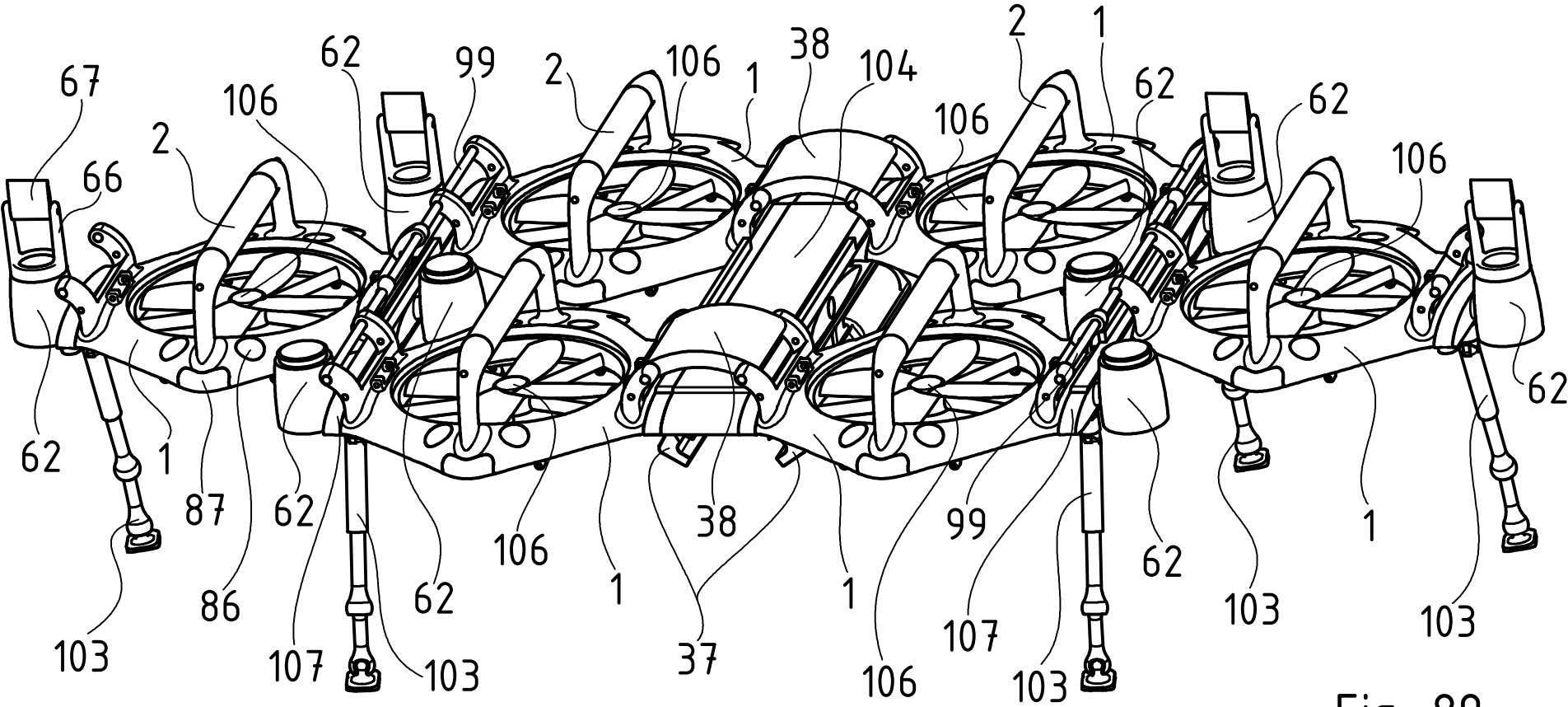

Fig. 89