

Z22

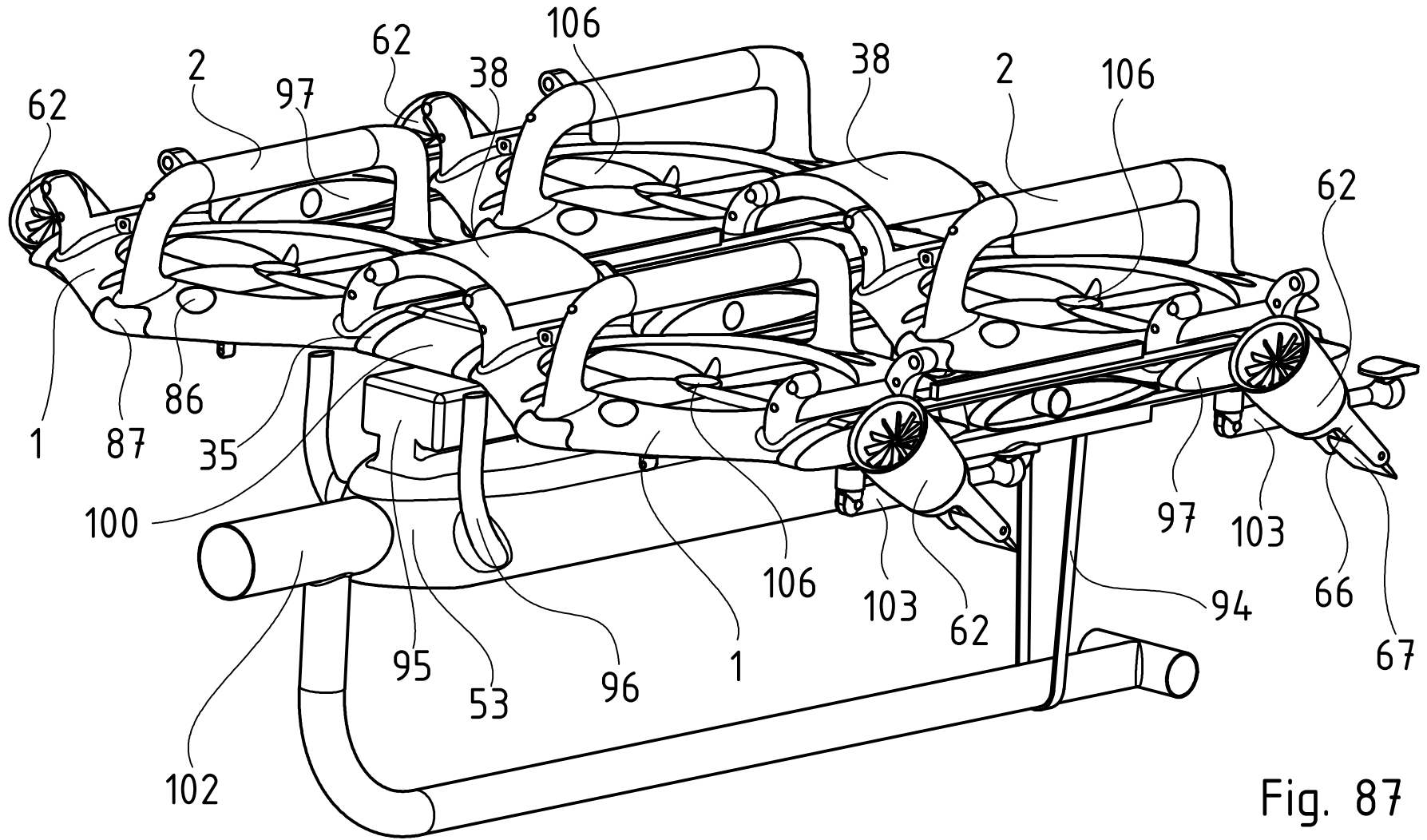

Fig. 87