

Z21

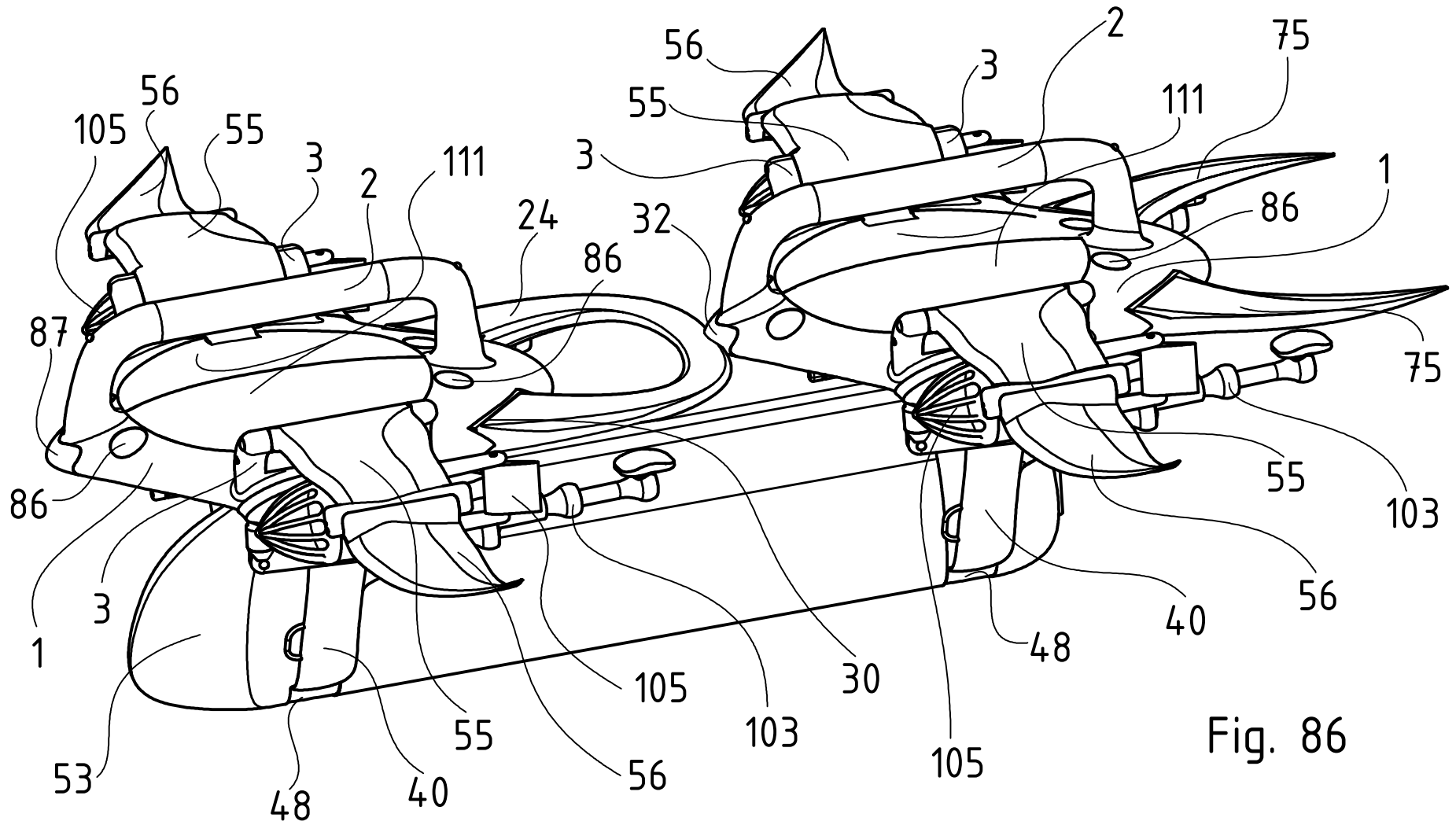

Fig. 86